

Outside Snap Rings

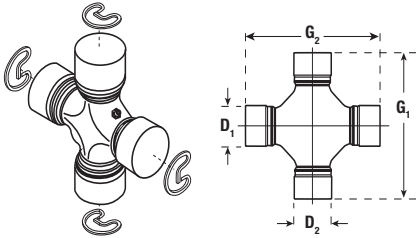

Inside Snap Rings

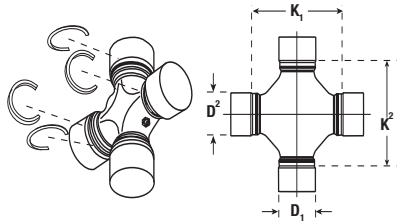

Wing™ Series

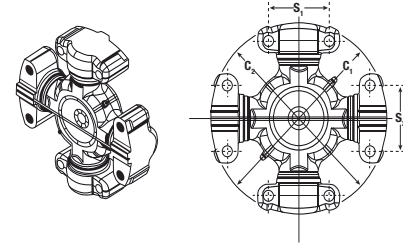

Bearing Plate Style

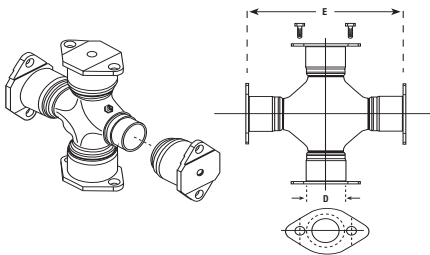

Spicer Life Series® (SPL® 140, 170, 250, and 350)

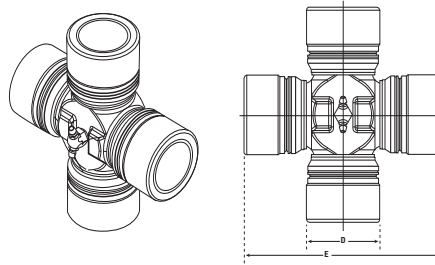

Half Round Style

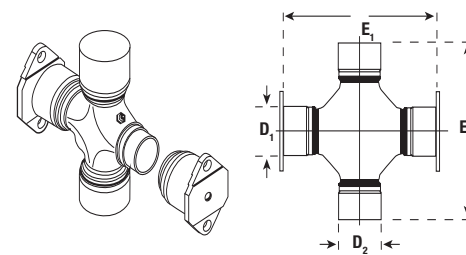

RPL Series

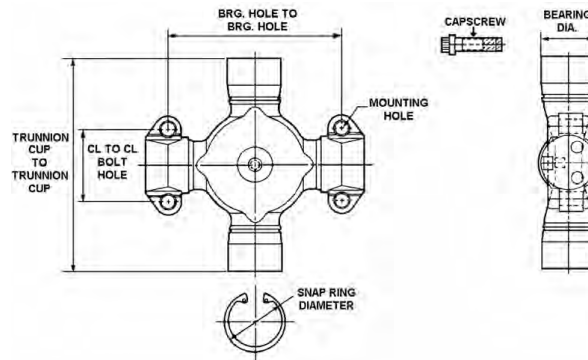

1. Choose your U-Joint Series.
2. Contact us at 508-754-6502 or info@mitchelldriveshafts.com